

# Substitute Type 02/45 Arisaka Data Sheet

Name \_\_\_\_\_ Telephone No. (\_\_\_\_) \_\_\_\_\_  
 (voluntary) E-mail address \_\_\_\_\_

Address \_\_\_\_\_ City \_\_\_\_\_ State \_\_\_\_\_ Zip \_\_\_\_\_

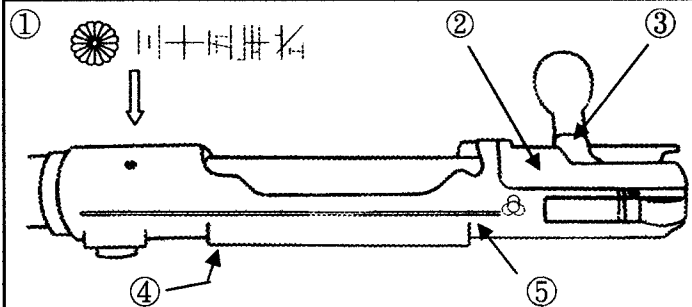

① Breech Top:  
 In tact  
 Ground

② Serial Number:  
 \_\_\_\_\_  
 No serial #

③ Bolt Number: \_\_\_\_\_

④ Assembly Number: \_\_\_\_\_

⑤ Dust Cover Rails:  
 Yes  No

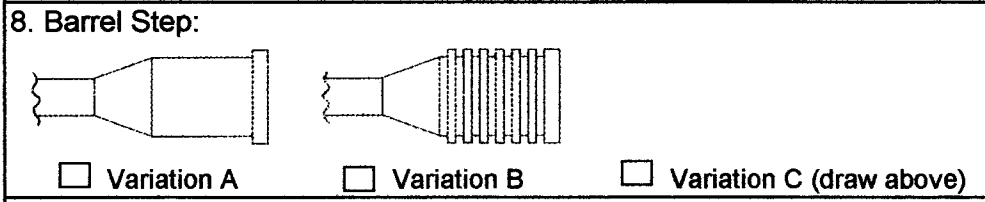
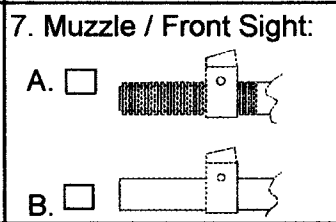
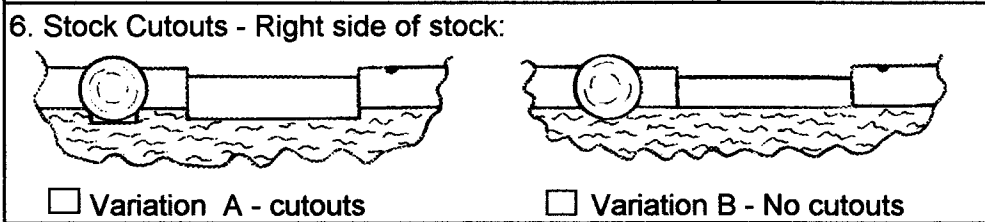

9. Barrel Step Markings:

A.  None  
 B.    
 O.  Other  
 X.  X (Reject)  
 Z.  廢

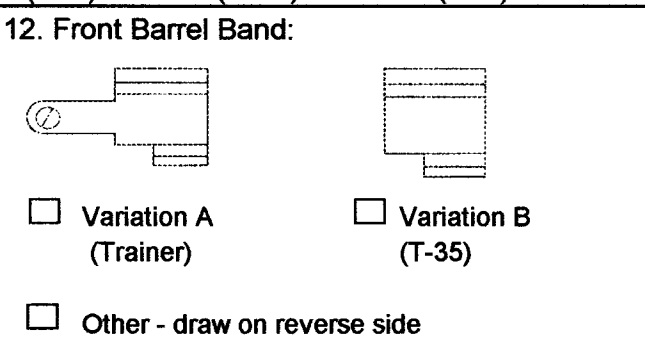
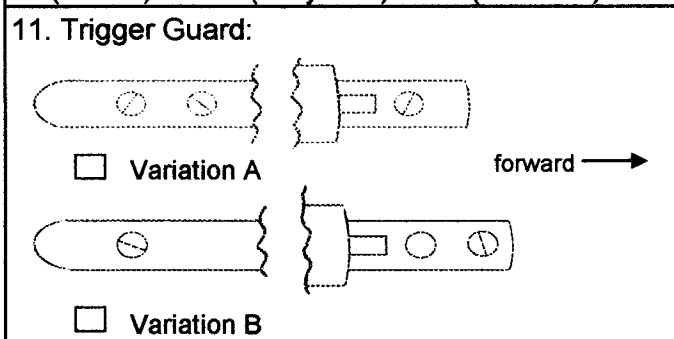
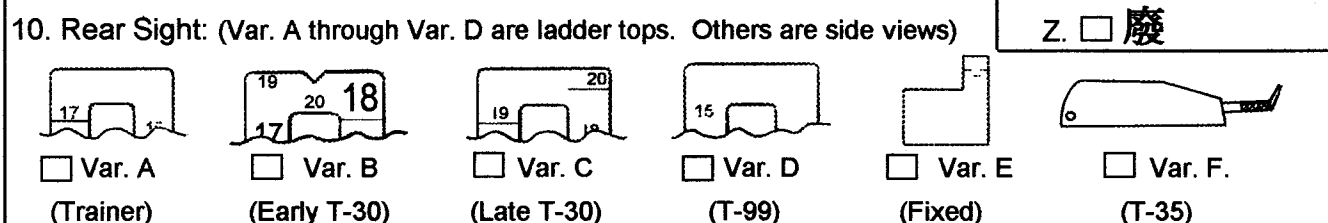

13. Buttplate:  
 A.  Forged  
 B.  Sheet Metal

14. Stock Stamps:  
 A.    
 B.    
 C.    
 D.    
 E.    
 F.    
 G.    
 H.    
 I.    
 J.    
 K.    
 L.    
 M.    
 N.  None  
 O.  Other (draw)

15. Stock: A.  One-piece B.  Two-piece

Comments: \_\_\_\_\_