



# Type 38 or Type 97 Sniper Rifle Data Sheet

Name \_\_\_\_\_ Telephone No. ( ) - \_\_\_\_\_  
 (voluntary) E-mail address \_\_\_\_\_  
 Address \_\_\_\_\_ City \_\_\_\_\_ State \_\_\_\_\_ Zip \_\_\_\_\_

1. Receiver Data: Left side forward receiver: (data positions differ between arsenals) Breech Top: (check box)







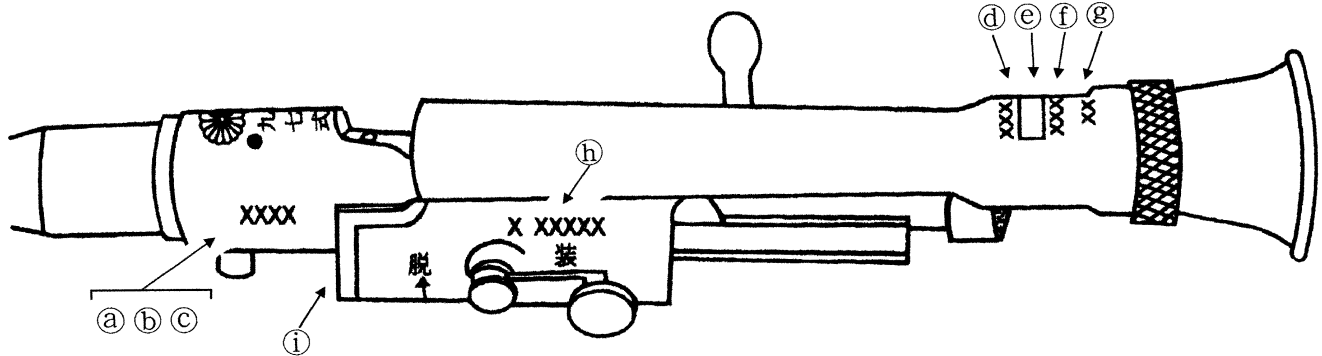

(a) - Serial Number: \_\_\_\_\_ Is the serial number preceded by ①?  Yes  No 三 九  
八 七  
式 式

(b) - Arsenal:  
 A.   Kokura B.   Nagoya C.  Other \_\_\_\_\_

(c) - Small Stamp: A.  小 = KO B.  名 = NA O.  Other \_\_\_\_\_



(d) - Scope Specifications:  2.5 X 10°  4 X 6°  Other \_\_\_\_\_

(e) - Scope Manufacturer's Logo:  
 A.   To ko B.   C.   NIKKO D.   AKATSUKI TOKYO  
 E.   EK F.   NTC KOGAKU H.   I.   J.   Other \_\_\_\_\_

(f) - Scope manufacturer's serial number: \_\_\_\_\_

(g) - Engineering notation:  JESねぢ  J.E.S.ねぢ  None

(h) - Scope mount serial number: \_\_\_\_\_ Preceded by ①?  Yes  No

(i) - Mount forward edge assembly number (Nikko scopes only) \_\_\_\_\_

2. Rear Barrel Band / Monopod: Kokura ↓ Nagoya ↓

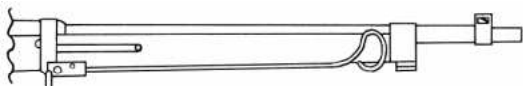
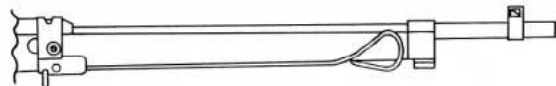
A.   B.  



C.  Monopod mounting block finished but monopod missing - Kokura D.  Monopod mounting block finished but monopod missing - Nagoya

E.  Monopod mounting block not finished (block not drilled) and no monopod - Kokura F.  Monopod mounting block not finished (block not drilled) and no monopod - Nagoya

G.  No provision for a monopod (No projection below the rear barrel band) - either arsenal H.  No monopod, but monopod marks on the forestock - either arsenal

3. Breech Top: A.   J.  Ground O.  Other

4. Barrel Step: A.   S N.  None O.  Other

5. Bridge Top: A.   B.   C.   N.  None O.  Other

6. Bottom of Receiver: Assembly Number \_\_\_\_\_  
 Too much trouble:

7. Bolt Number: \_\_\_\_\_

8. Bolt Stop Latch Release Number: \_\_\_\_\_

9. Bolt Stop Latch Release Variation:

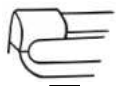
 C.

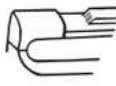
 D.

 E.

Other (draw or note) O.

12. Front Sight:

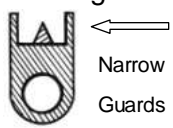
 Narrow Guards (under 2.5mm) B.

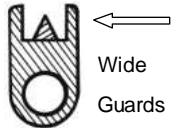
 Wide Guards (2.5mm or over) C.

 D.

O.  Other (Draw in comments section)

13. F. S. Guard:

 A.

 B.

N.  None

O.  Other

16. Rear Sight:

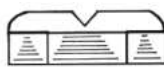
A.  

B.  

C.  

18. Rear Ladder:

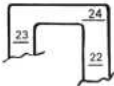
A.  

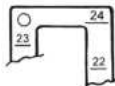
B.  

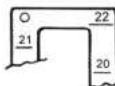
C.  

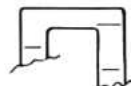
O.  Other 

19. Buttplate:

A.  Flat 

B.  Cupped 

20. Rear Sling Swivel:

A.  Contoured 

B.  Semicircular 

21. Stock: A.  One-piece B.  2-piece

22. Chromed Bolt Face: Y.  Yes N.  No K.  Can't determine

23. Chrome Bore: Y.  Yes N.  No

24. Bolt Metal Finish: A.  Blue B.  White

25. Safety Knob Metal Finish: A.  Blue B.  White

26. Rifling: A.  4-Grove B.  6-Grove K.  Can't determine

27. Caliber: A.  6.5x50SR (6.5 Jap.) O. Other \_\_\_\_\_

28. China Import / Import Stamp: Y.  Yes N.  No K.  Can't determine

Strawed Parts:

10. Latch Spring: Y.  Yes N.  No K.  Can't determine

11. Trigger: Y.  Yes N.  No K.  Can't determine

14. F S. Fasteners:

A.  1 pin

B.  2 Pins

C.  1 Screw

N.  None

O.  Other

15. Fasteners Visible

A.  Flush

B.  Protruding

17. Safety Knob: No. \_\_\_\_\_

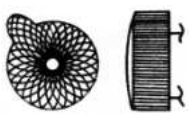
A.  Large Tang 

B.  Small Tang 

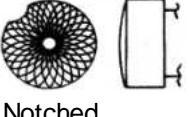
C.  Notched 

29. CASE: (a) Leather:  Cloth Covered: Tan  Green

(b) Cleaning Rag  Yes  No  No provision

(c) Brush:  Yes  No  No provision

(d) Lid Closure Strap: Material \_\_\_\_\_ Attachment \_\_\_\_\_  
 Liner: Material \_\_\_\_\_ Color \_\_\_\_\_  
 Keeper: Material \_\_\_\_\_ Attachment:  Stitched  Riveted  
 Buckle: Material \_\_\_\_\_ Paint \_\_\_\_\_

(e) Lid Stitching:  Yes  No

(f) Overhang:  Square  Sloped  
 Reinforcement: Material \_\_\_\_\_ No. Screws \_\_\_\_\_

(g) Left side of case:  Folded  Stitched

(h) Shoulder Strap:  Yes  Type (a)  Type (b)  
 Leather  Web  Cloth Marks: \_\_\_\_\_  
 Buckle type:  Slide  Toggle Material: \_\_\_\_\_

(i) Waist Belt:

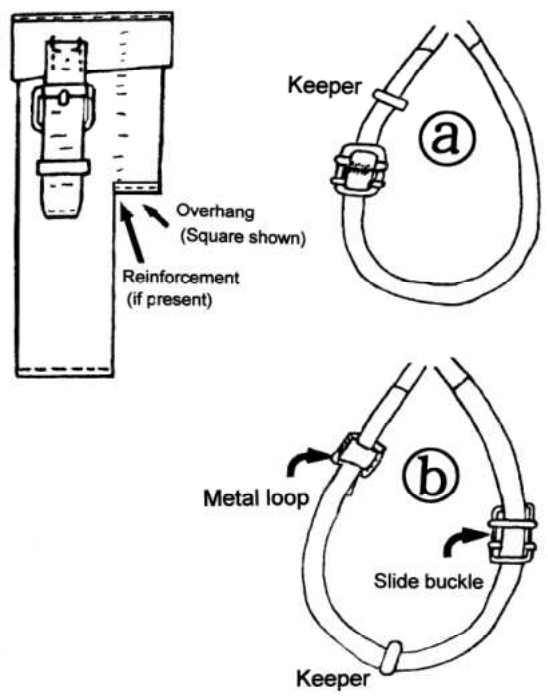

Comments: \_\_\_\_\_  
 \_\_\_\_\_  
 \_\_\_\_\_  
 \_\_\_\_\_