











Japanese Type 99 Rifle Data Sheet – Part II-DRAFT

Series Mark: 0 (None) 1: ① 2: ② 3: ③ 4: ④ 5: ⑤ 6: ⑥ 7: ⑦ 8: ⑧ 9: ⑨ 10: ⑩ 11: ⑪ 12: ⑫ 20: ⑳

21: ㉑ 22: ㉒ 23: ㉓ 24: ㉔ 25: ㉕ 27: ㉖ 30: ㉗ 31: ㉘ 32: ㉙ 33: ㉚ 34: ㉛ 35: ㉜ 37: ㉝ 40: ㉞ 45: ㉟





21) Inspection Marks for Rifle, Series: _____ Serial Number: _____





Nagoya Army Arsenal  Kokura Army Arsenal  Toyo Kogyo  

N1: 名 N5:  K1: 小 K4: 特 TK1: 廣 TK4: 社 TK7:  TK10: ②
 N2: リ N6:  (2mm) K2: セ K5: TK2: セ TK5: 永士 TK8:  TK11: イ
 N3: チ N7:  K3: ス K6: TK3: 小 TK6:  TK9:  TK12: 特
 N4: □ N8: ②

Jinsen Army Arsenal  Tokyo Juki Kogyo   Mukden Army Arsenal (Hoten) 

J1: 仁 J4:  (2mm) TJK1: 東 TJK4: 森 TJK7:  M1: 奉 M4: ㊦
 J2: フ J5:  (4mm) TJK2: セ TJK5: 名 TJK8: 土 M2: ㇀ M5:
 J3: セ J6: 特 TJK3: 社 TJK6: リ M3: ㊥ M6:

Izawa (Dai Nippon Juho KK)   Howa   Others not listed:

I1: 名 I4:  (2mm) H1: 名 H4: 土 O1: O4:
 I2: リ I5:  H2:  H5: O2: O5:
 I3:  I6: H3:  (2mm) H6: O3: O6:

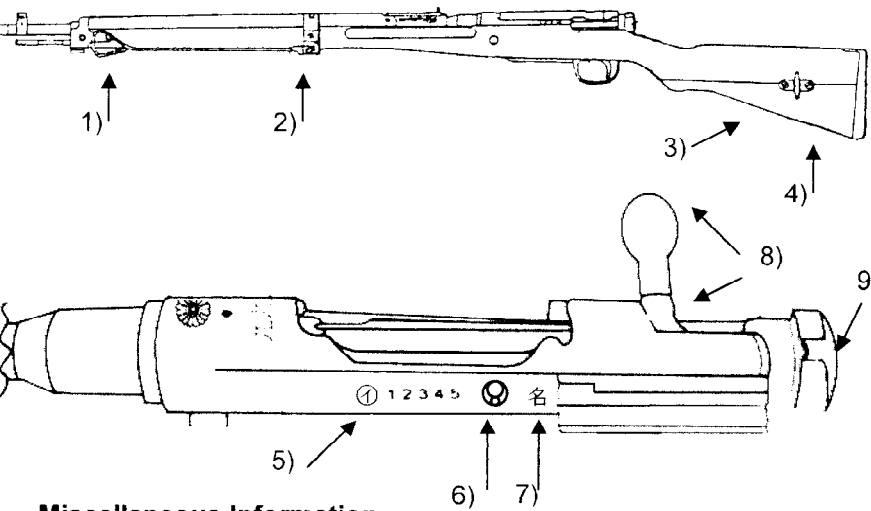

Inspection Marks
(Please fill out using above codes/marks)

1) Monopod Foot: _____
 2) Monopod Base: _____
 3) Final Inspection Mark: _____
 4) Factory Inspection Mark: _____
 5) Series Mark: _____
 6) Arsenal Symbol: _____
 7) Inspection Mark: _____
 8) Bolt Inspection Mark(s): _____
 9) Safety Mark(s): _____
 10) Firing Pin(not shown): _____
 11) Extractor(not shown): _____
 12) Other _____

Miscellaneous Information

- Was rifle disassembled for inspection?: YES NO Barrel/Receiver Group Assembly Number(s): _____
- Does the Rifle have an original sling ? YES NO Describe: _____
- Are there Kanji markings on the exterior of the stock or sling ? YES NO Describe: _____
- History of rifle (if known): _____
- Additional Comments: _____